

Motorscope - Trio Panel

THREE PHASE / 4.2kW - 7.5kW / 400V

Includes capacitors, ON/OFF switch and surge arresters

TECHNICAL SPECS

MOTOR VOLTAGE	: L1- L2- L3 = 400V AC
CURRENT RANGE	: 1 - 15 Amp Inductive
POWER RANGE	: 4.2 - 7.5kW
FREQUENCY RANGE	: 40 - 70 Hz
CONSUMPTION	: 3VA
COS PHI RANGE	: 0 - 1 Inductive
TEMP RANGE	: -15 to +70° C
MECHANICAL	: Weight ±1.5kg
DIMENSIONS	: 158 x 238 x 100mm

AUXILIARY INPUT

LIQUID LEVEL
PRESSURE
TEMPERATURE
EARTH LEAKAGE

PROTECTION

- * OVER- and UNDER-LOAD
- * OVER- and UNDERVOLTAGE
- * PHASE FAILURE
- * PHASE SEQUENCE CHANGES
- * PHASE IMBALANCE
- * OVERHEATING (UNCONTROLLED STARTS)
- * CAN'T CALIBRATE IN OVERLOAD
- * NOT AGAINST LIGHTNING

GENERAL INFORMATION

The power used by a working system varies with the application but must stay within safe limits. Power consumption outside of this range indicates a faulty motor or system. The load or power consumption is measured at the input to the motor. When the calibration button is pressed, with the jumper in place, the **MOTORSCOPE** defines the safe range for the system. The motor must, at that time, run under normal working conditions. The power supply has to be correct and stable, this is checked continuously. The **MOTORSCOPE** keeps the motor running as long as the safe limits are not exceeded. The **MOTORSCOPE** has a **RS232** output for serial communication with our **OPTIMIZER** or a **PC**. The **OPTIMIZER** is used to improve settings, as an installation aid and for more detailed fault indication. The **OPTIMIZER** can carry the data of the last 43 motor stops to be transferred to a **PC**. Do not mount the unit in full sun.

POSSIBLE ERRORS AT FIRST TIME CALIBRATION

● LIGHT ON ○ LIGHT OFF ✱ LIGHT FLASHING

NOTE: Start fault finding by checking that all wires and compressed copper connections are properly connected, and that the motor is calibrated at it's normal running condition.

<u>LED Indication:</u>	<u>Reason</u>	<u>Possible cause</u>	<u>Solution</u>
✱ ✱ ○ , Red and Yellow lights flashing	Voltage fault (When the supply voltage recovers and stays within the safe limits for 15 min, normal operation resumes.) Under-load / Restart timer	Supply voltage incorrect	Connect Earth(⏚) to COM. Phone your power supply company.
○ ✱ ○ , Yellow light flashing		Bore-hole dry Broken belt/shaft Over current	Set Restart-timer, for bore-hole to refill. Phone your motor's supplier Current exceeds safe limit.
● ✱ ○ , Red constant and Yellow flashing	Current fault		
○ ✱ ✱ , Yellow and Green lights flashing	Start delay	Too rapid restart	Leave on, unit restarts automatically.
● ● ○ , Red and Yellow constant	Phase rotation error	2 Phase wires interchanged Check motor rotation	Interchange 2 phase wires at input power connector. Interchange 2 motor leads at output from contactor.
● ○ ○ , Red constant	Overload	Low voltage at motor Overload	Use a larger diameter cable to motor Check system or contact supplier.

Installation Instructions

1. Connect the incoming power (**L1, L2, L3** and **Earth**) to the Trio-panel as indicated on the diagram below.
2. Connect the outgoing power to the motor as per diagram (Do not forget to earth the motor as indicated).
3. When all connections are properly fastened, proceed with the **First Time Calibration** (See instructions below).
4. For 0.37kW motors: L3 should go through the CT twice (in the same direction).

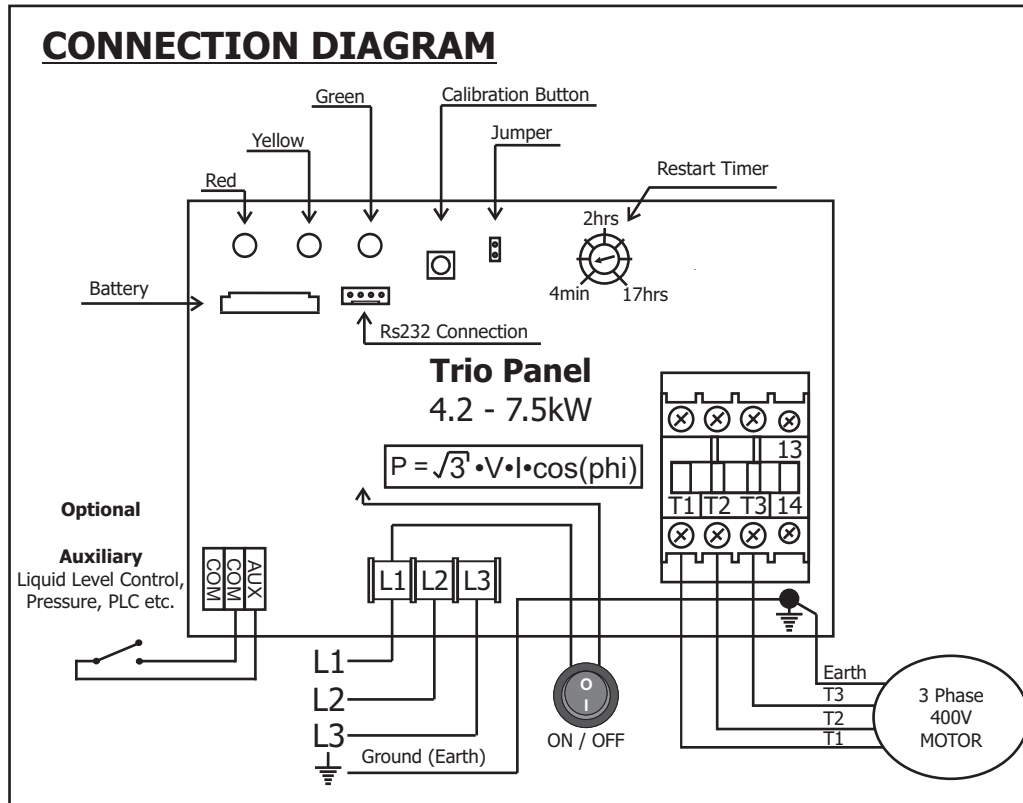

TO START OR STOP, USE THE ON/OFF SWITCH AT THE BOTTOM OF THE ENCLOSURE.

FIRST TIME CALIBRATION:

(Ensure that all wires and the motor's earth are properly connected before **First Time Calibration**)

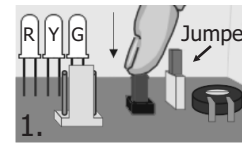

Connect the **jumper** to the two pins as indicated above. Press the **calibration button** while switching the power on at the **ON/OFF** switch on the bottom of the unit.

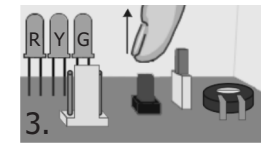
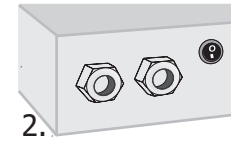

When all the indication lights glow, release the **calibration button** for one second.

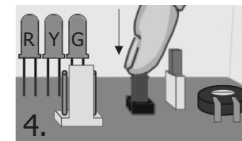

Press the **calibration button** again until the motor starts (± 3 sec). The calibration will start automatically.

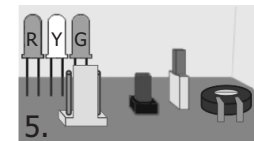

First the **RED** and **GREEN** light will glow for 4 seconds, indicating that calibration is in progress.

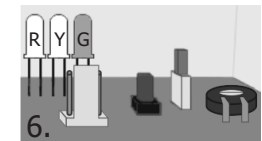

The calibration is completed when only the **GREEN** light glows.

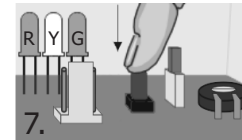

After the pump has run for approximately 5 min; press the **calibration button** again until the **RED** and **GREEN** lights glow, to optimize the automatic calibration.

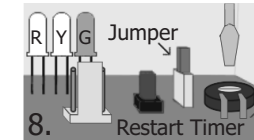

Calibration is finished when only the **GREEN** light glows. Place the **jumper** on one pin to keep the set limits and to prevent tampering. Adjust the **Restart Timer** (with a screwdriver) to set the dry-run recovery time.

YOUR SYSTEM IS NOW RUNNING WITHIN SAFE LIMITS WHICH WILL SUIT 95% OF ALL SYSTEMS.

THE OPTIMIZER MAY BE USED TO CUSTOMIZE THE LIMITS TO SUIT YOUR SPECIFIC APPLICATION.

IF ANY ERRORS OCCURRED DURING START-UP, SEE THE REVERSE SIDE FOR POSSIBLE EXPLANATIONS.